

Item 1

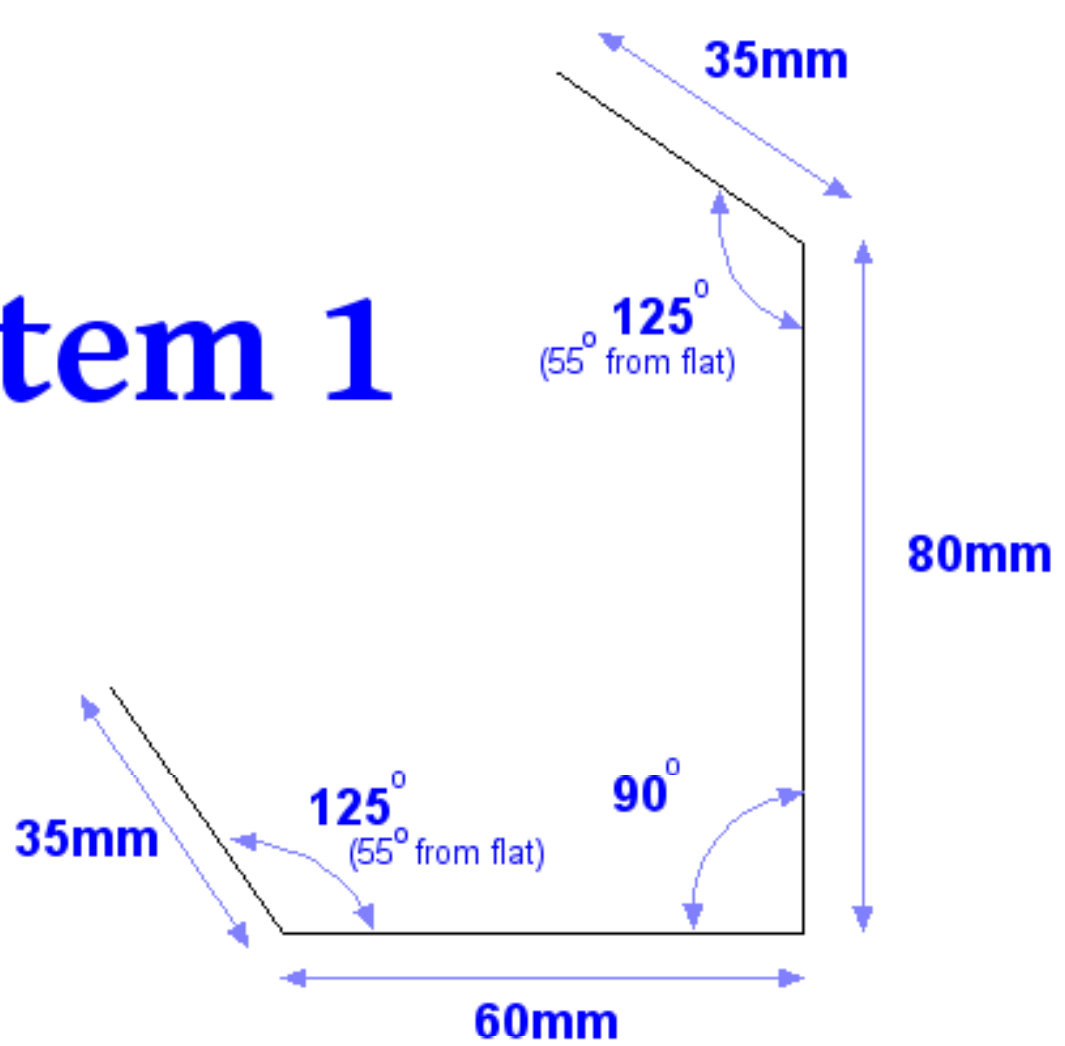

Item 2

